

Профили автомобильные

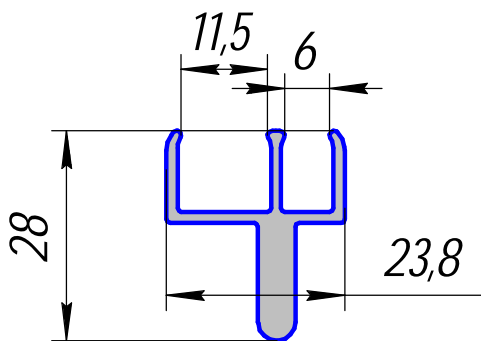

HP-270; 0,430кг/п.м.
(ПС 885-1299)

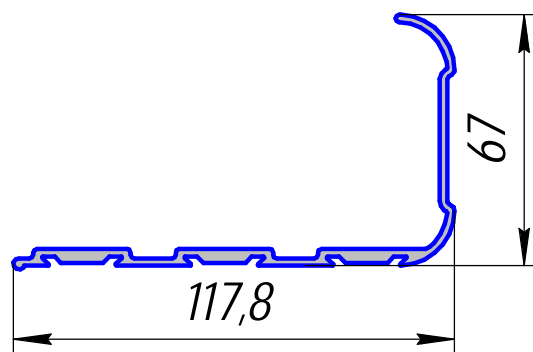

HP-334; 1,339кг/п.м.

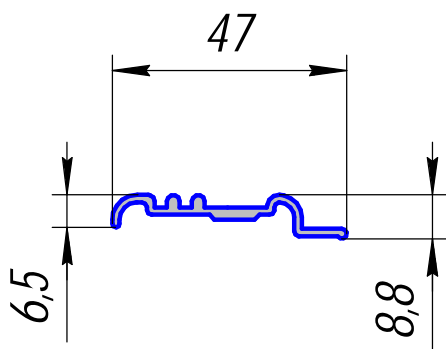

HP-324; 0,295кг/п.м.

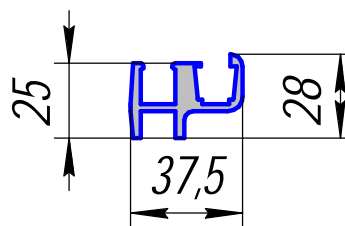

HP-360; 0,901кг/п.м.

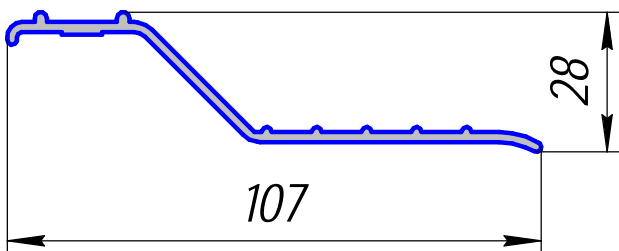

HP-325; 0,692кг/п.м.

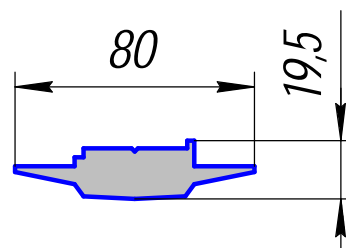

HP-361; 2,172кг/п.м.

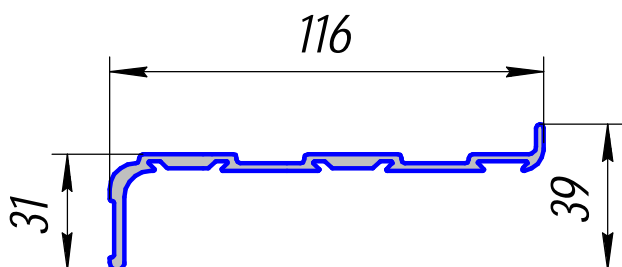

HP-333; 1,156кг/п.м.

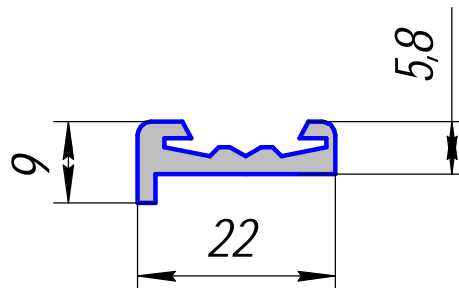

HP-362; 0,227кг/п.м.

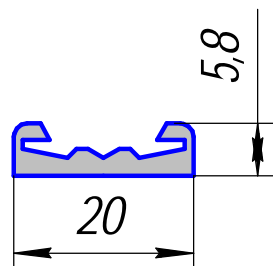

HP-363; 0,179кг/п.м.

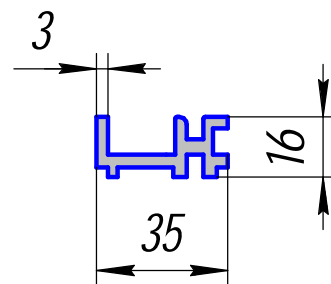

HP-367; 0,663кг/п.м.
(ПА-186)

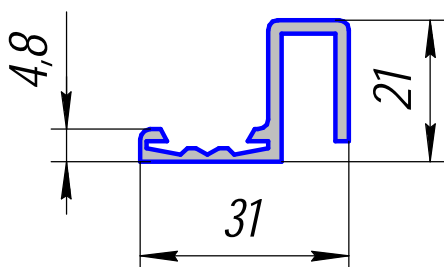

HP-364; 0,366кг/п.м.

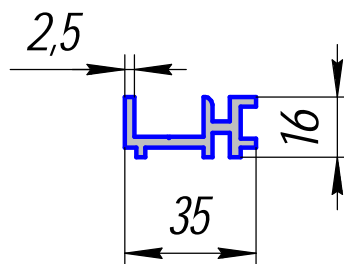

HP-367-01; 0,586кг/п.м.
(ПА-186-01)

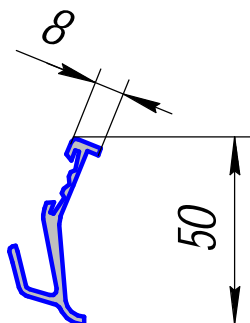

HP-365; 0,522кг/п.м.
(ПА-184)

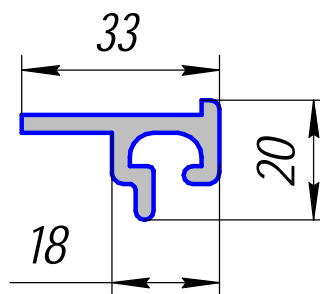

HP-368; 0,540кг/п.м.

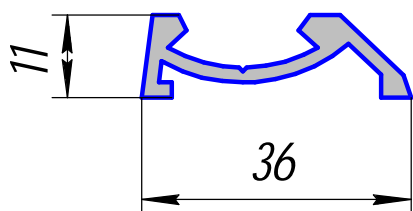

HP-366; 0,356кг/п.м.

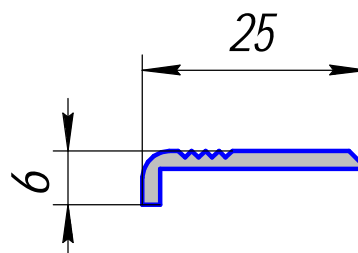

HP-369; 0,140кг/п.м.

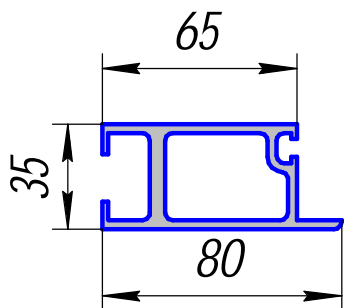

HP-370; 1,966кг/п.м.

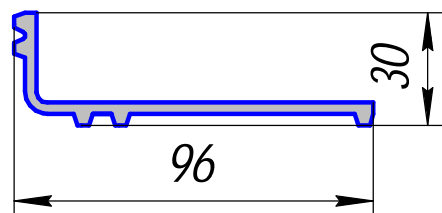

HP-376; 1,101кг/п.м.

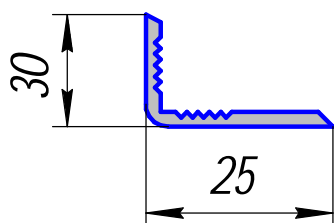

HP-372; 0,177кг/п.м.

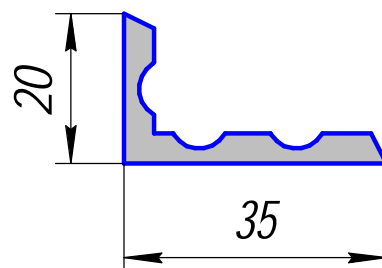

HP-377; 0,451кг/п.м.

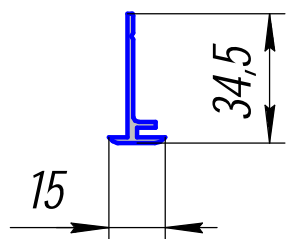

HP-374; 0,22кг/п.м.

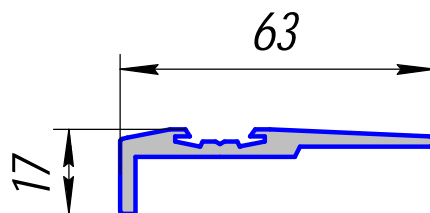

HP-378; 0,668кг/п.м.
ПА-187

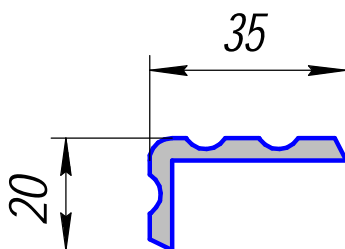

HP-375; 0,442кг/п.м.

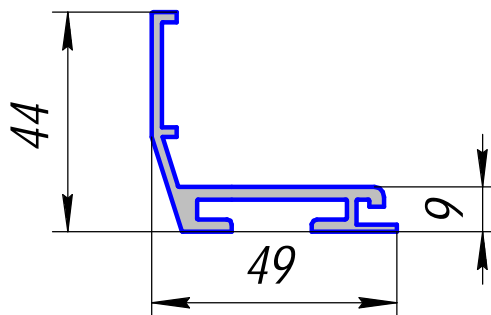

HP-380; 0,758кг/п.м.
(ПА-10-10)

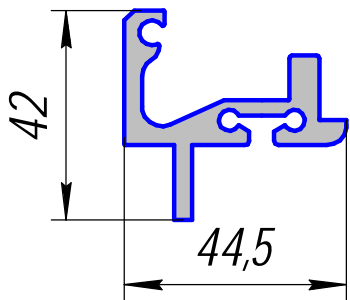

HP-381; 1,201кг/п.м.
(ПА-2-10)

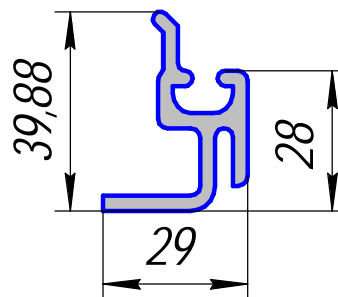

HP-385; 0,828кг/п.м.

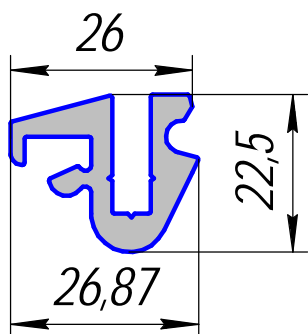

HP-382; 0,654кг/п.м.
(ПА-3)

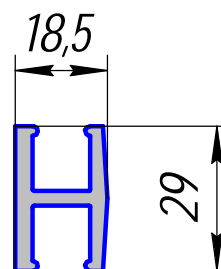

HP-386; 0,622кг/п.м.

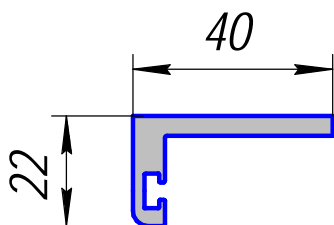

HP-383; 0,677кг/п.м.

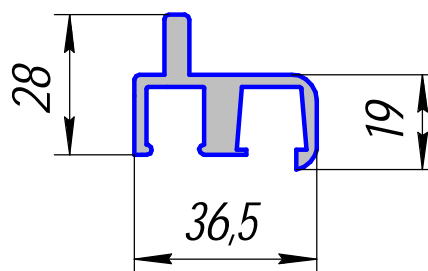

HP-387; 0,869кг/п.м.
(ПА-003-01)

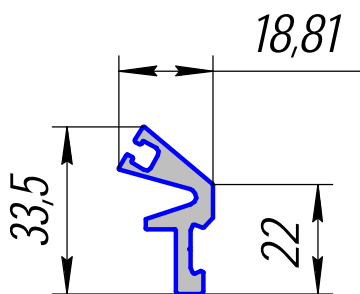

HP-384; 0,528кг/п.м.

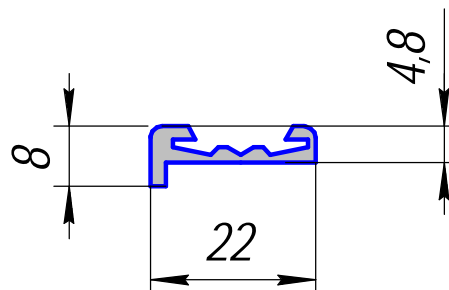

HP-388; 0,168кг/п.м.
(ПА-144)

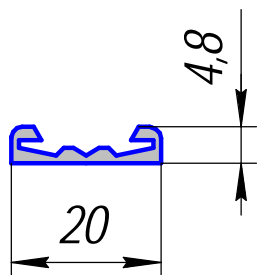

HP-389; 0,124кг/п.м.
(ПА-145)

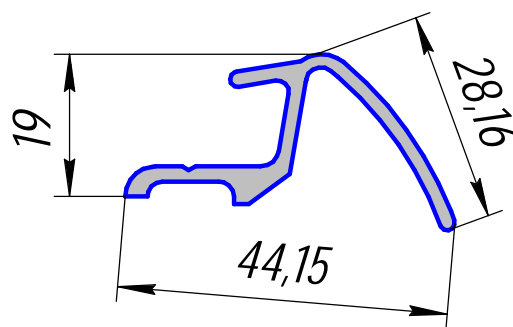

HP-399; 0,453кг/п.м.

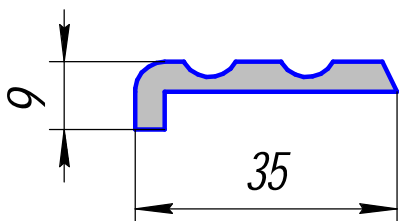

HP-390; 0,360кг/п.м.
(ПА-019)

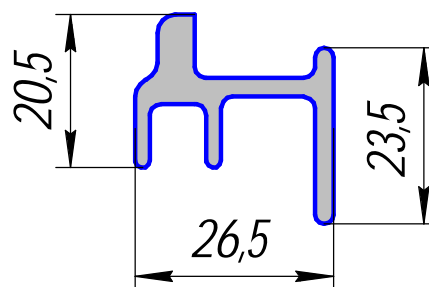

HP-400; 0,557кг/п.м.

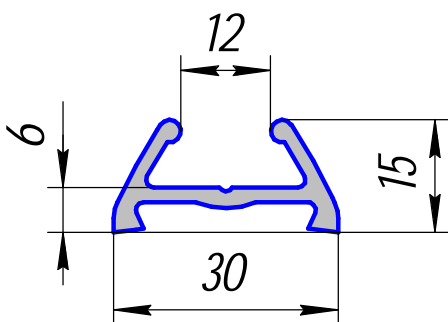

HP-396; 0,355кг/п.м.

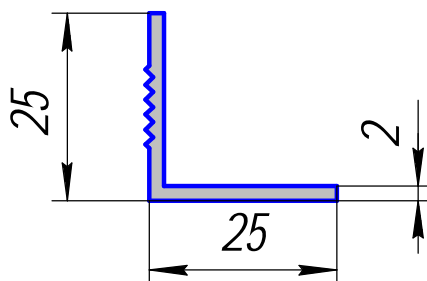

HP-402; 0,261кг/п.м.

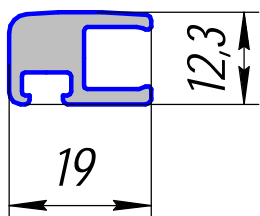

HP-397; 0,352кг/п.м.

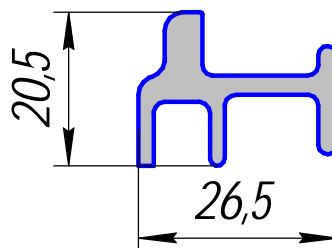

HP-404; 0,498кг/п.м.

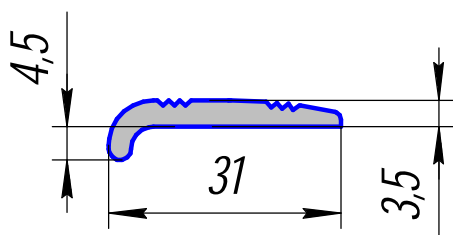

HP-405; 0,279кг/п.м.

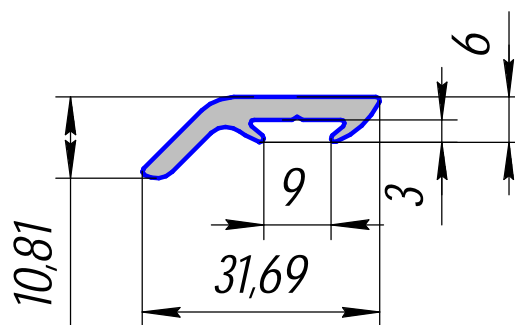

HP-425; 0,311кг/п.м.

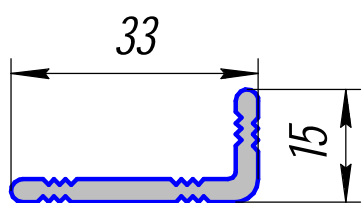

HP-406; 0,328кг/п.м.

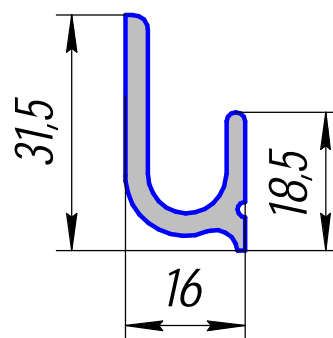

HP-426; 0,424кг/п.м.

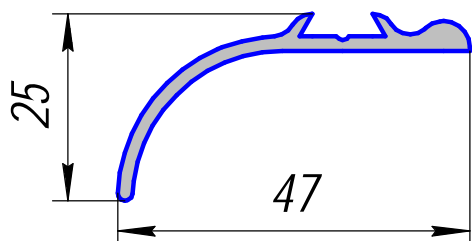

HP-408; 0,366кг/п.м.

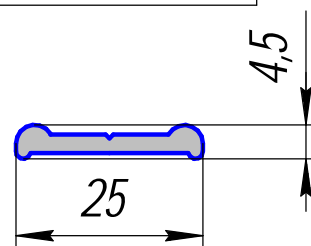

HP-427; 0,195кг/п.м.

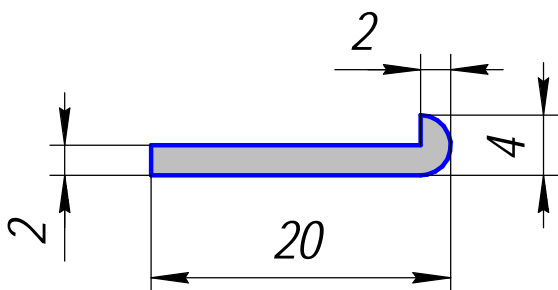

HP-424; 0,115кг/п.м.

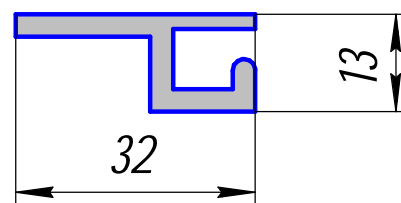

HP-429; 0,431кг/п.м.

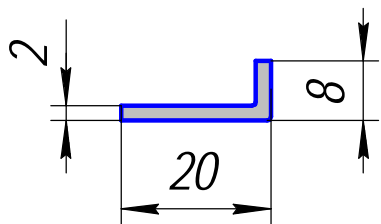

HP-430; 0,141кг/п.м.

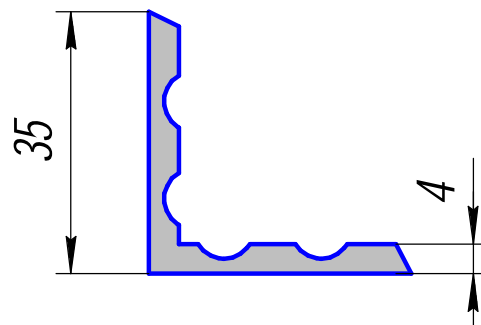

HP-434; 0,587кг/п.м.

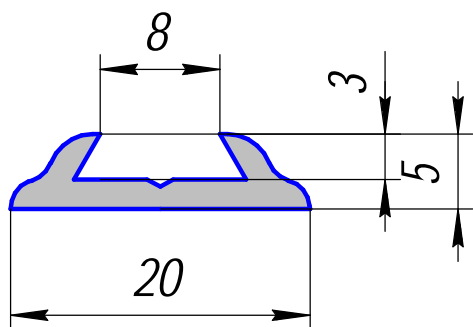

HP-431; 0,137кг/п.м.

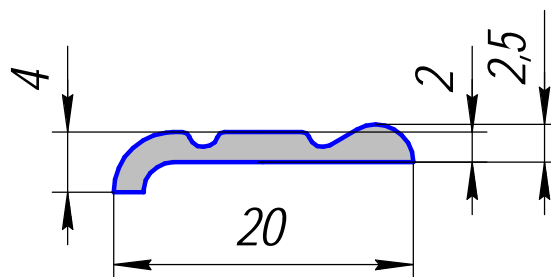

HP-435; 0,104кг/п.м.

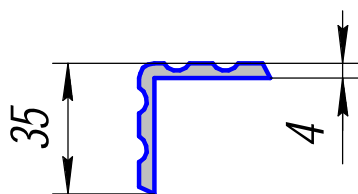

HP-432; 0,578кг/п.м.

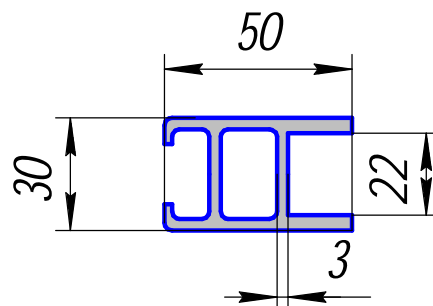

HP-436; 1,353кг/п.м.

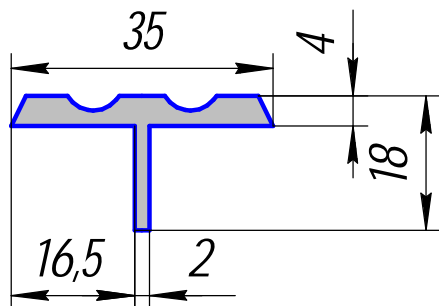

HP-433; 0,381кг/п.м.

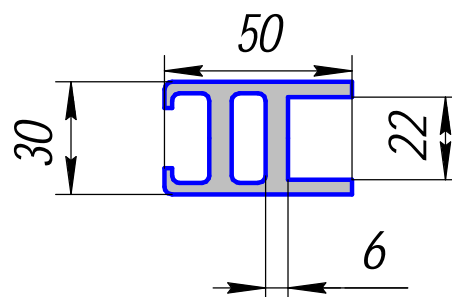

HP-436-01; 1,743кг/п.м.

Профили автомобильные

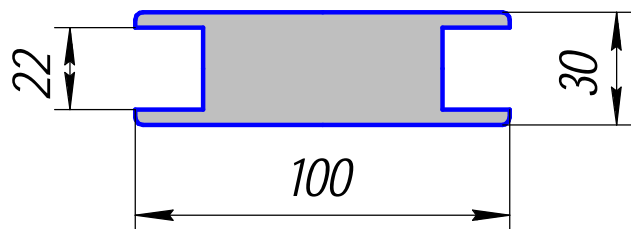

HP-437; 5,975кг/п.м.

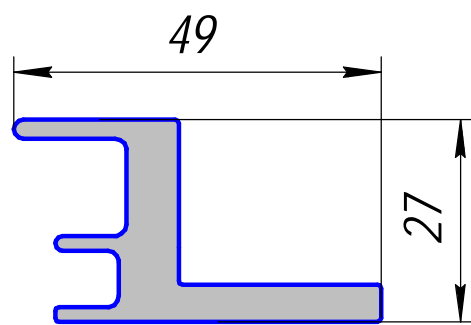

HP-508; 1,105кг/п.м.

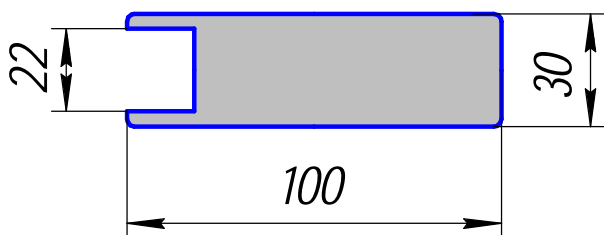

HP-438; 7,047кг/п.м.

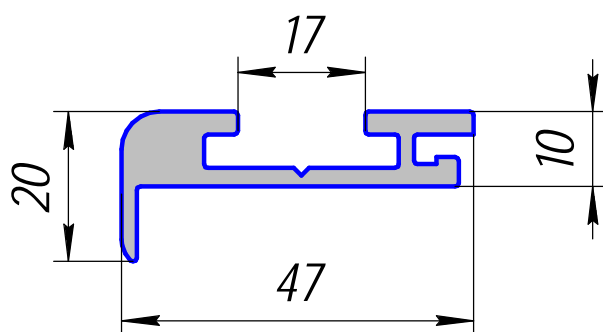

HP-509; 0,757кг/п.м.

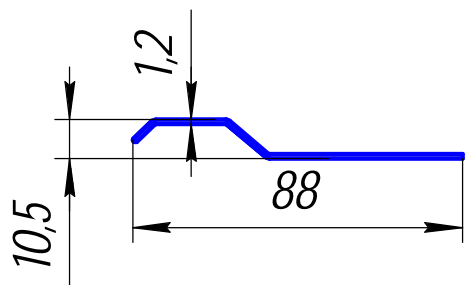

HP-505; 0,303кг/п.м.

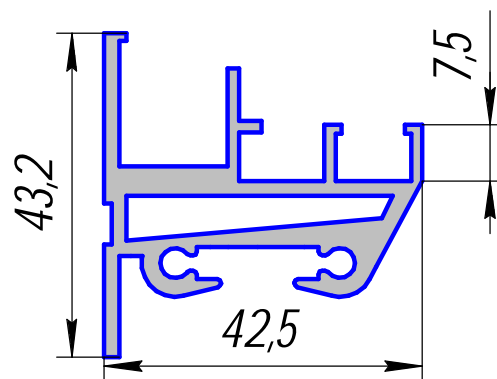

HP-511; 1,129кг/п.м.

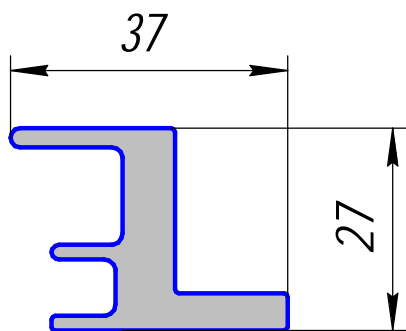

HP-507; 0,942кг/п.м.

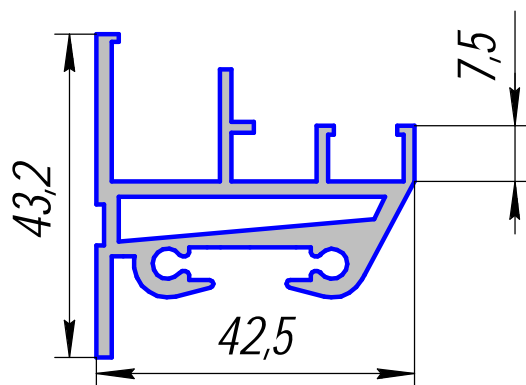

HP-512; 1,050кг/п.м.

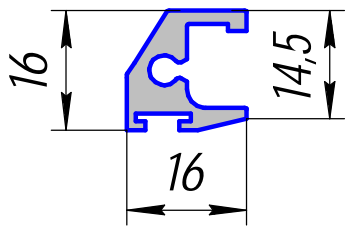

HP-513; 0,309кг/п.м.

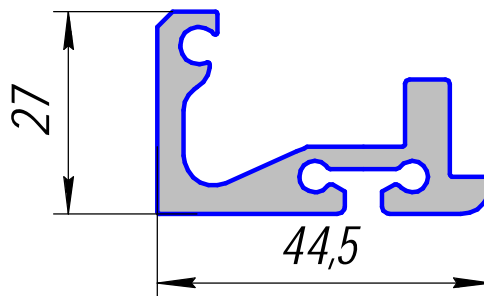

HP-517; 1,061кг/п.м.

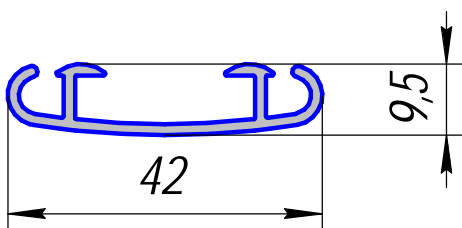

HP-514; 0,307кг/п.м.

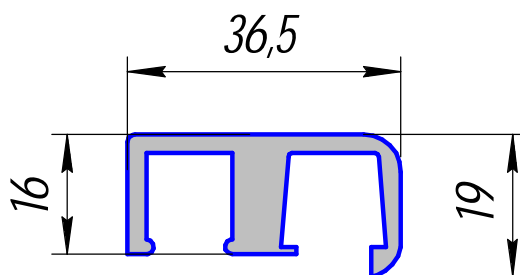

HP-518; 0,708кг/п.м.

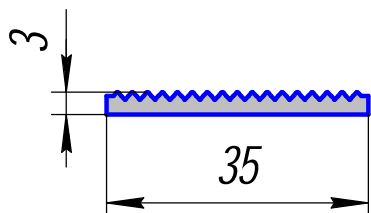

HP-515; 0,24кг/п.м.

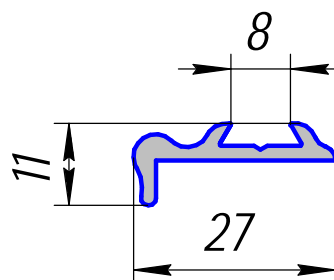

HP-519; 0,227кг/п.м.

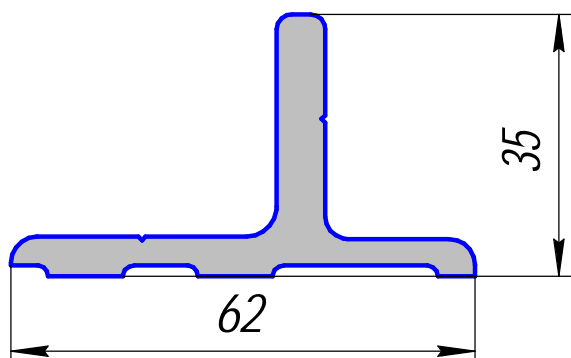

HP-516; 1,248кг/п.м.

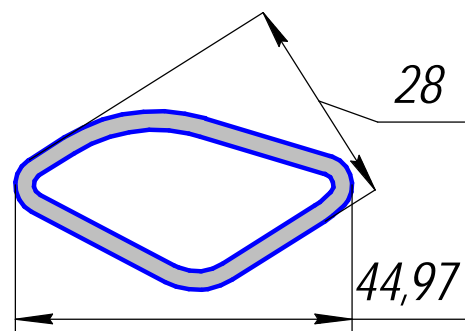

HP-540; 0,669кг/п.м.

Профили автомобильные

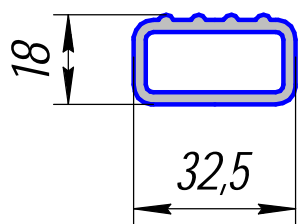

HP-570; 0,595кг/п.м.

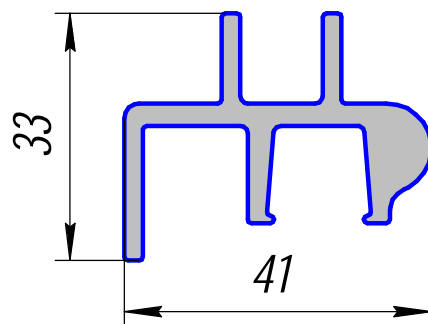

HP-590; 0,926кг/п.м.

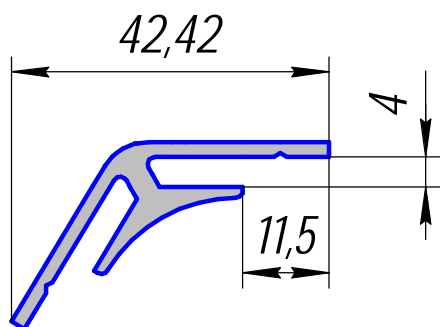

HP-587; 0,491кг/п.м.

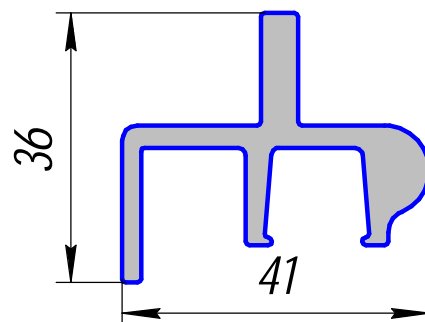

HP-591; 0,966кг/п.м.

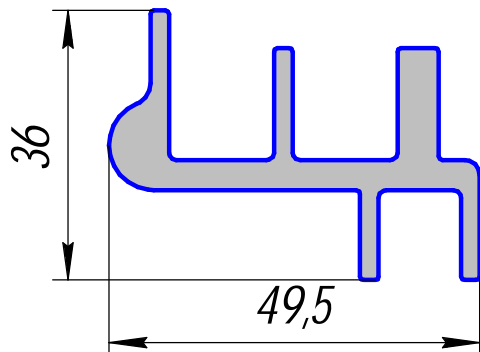

HP-588; 1,24кг/п.м.

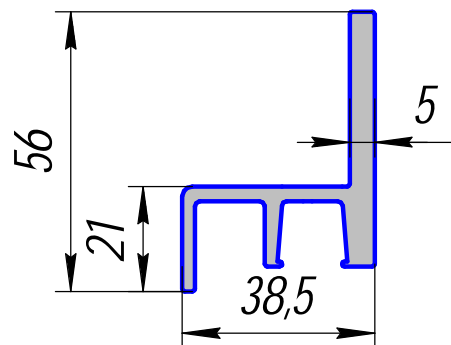

HP-593; 1,227кг/п.м.

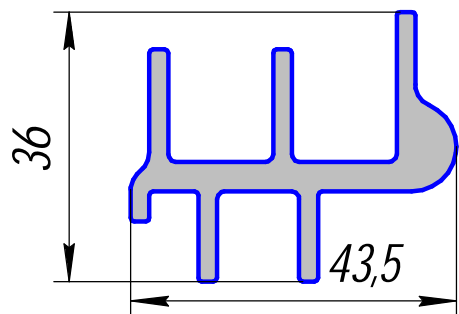

HP-589; 1,073кг/п.м.

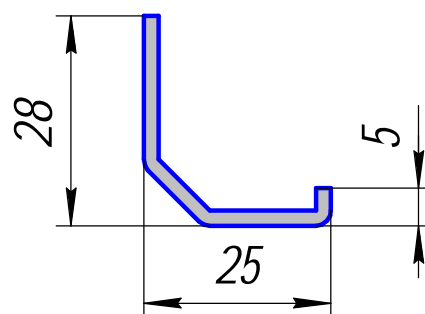

HP-595; 0,266кг/п.м.

Профили автомобильные

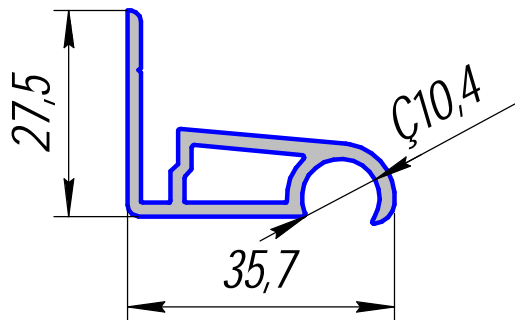

HP-596; 0,508кг/п.м.

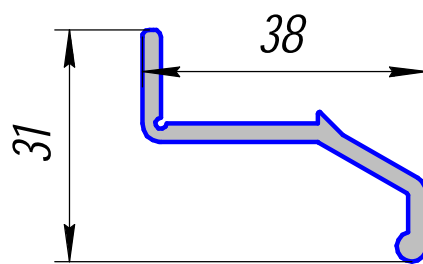

HP-600; 0,420кг/п.м.

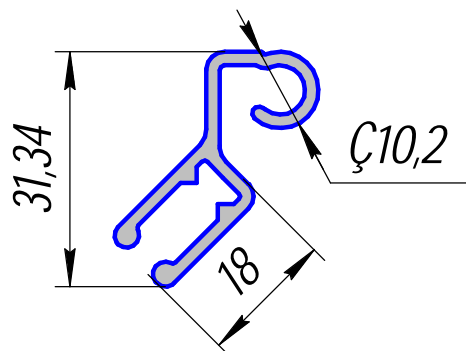

HP-597; 0,421кг/п.м.

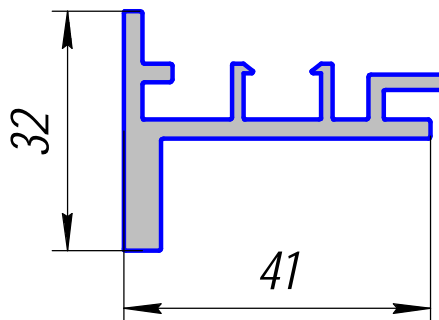

HP-601; 0,749кг/п.м.

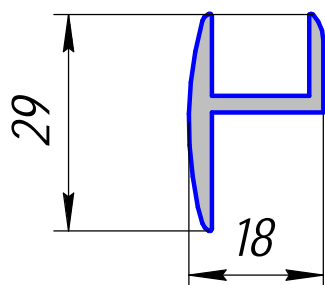

HP-598; 0,329кг/п.м.

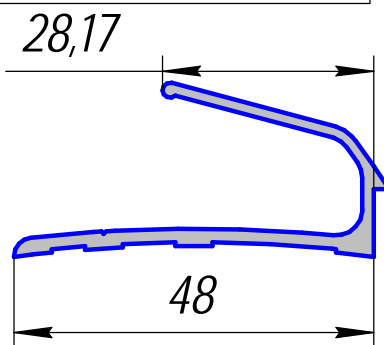

HP-602; 0,440кг/п.м.

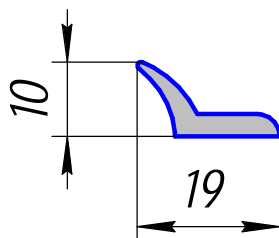

HP-599; 0,163кг/п.м.

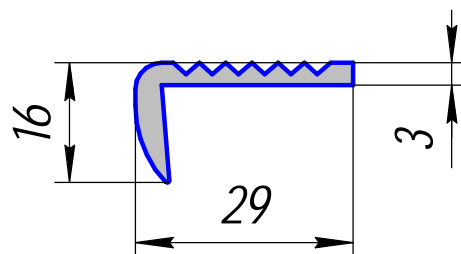

HP-603; 0,292кг/п.м.

Профили автомобильные

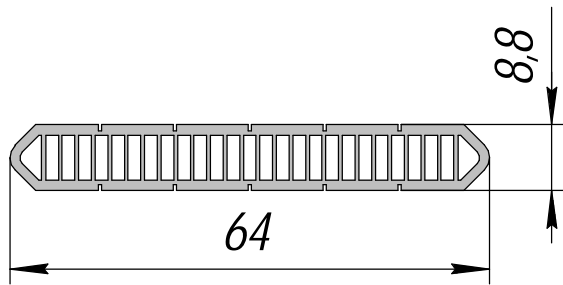

НП-608; 0,703кг/п.м.

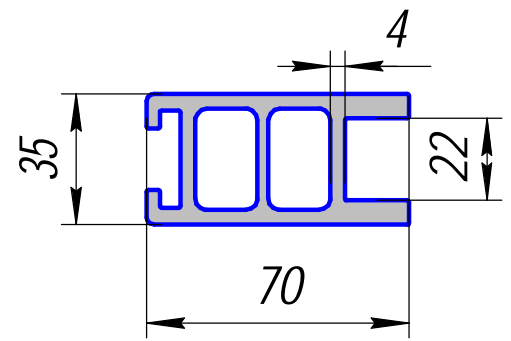

ПА-11; 2,704кг/п.м.

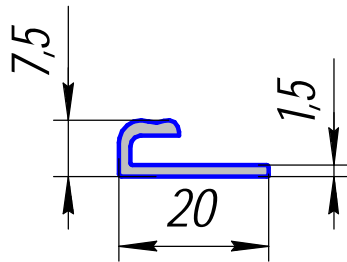

НП-631; 0,134кг/п.м.

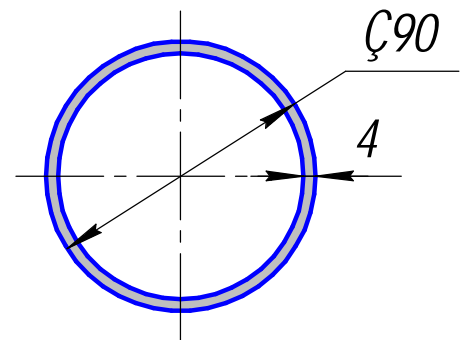

ПА-12; 2,929кг/п.м.

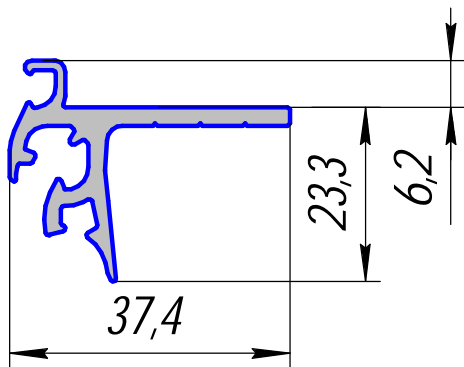

НП-640; 0,52кг/п.м.

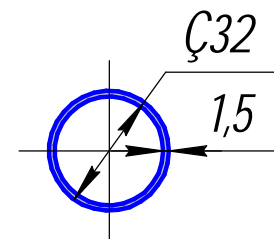

ПА-13; 0,389кг/п.м.

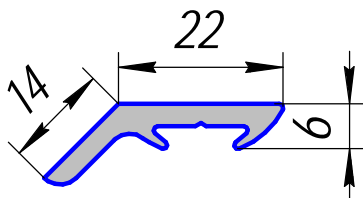

ПА-090; 0,312кг/п.м.

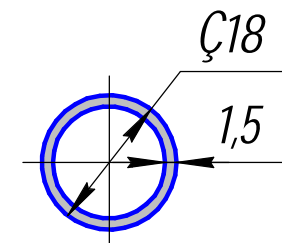

ПА-14; 0,211кг/п.м.

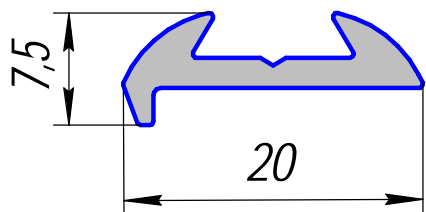

ПА-45; 0,155кг/п.м.

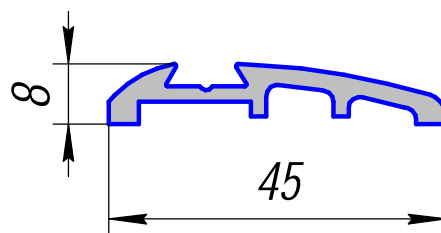

ПА-50; 0,405кг/п.м.

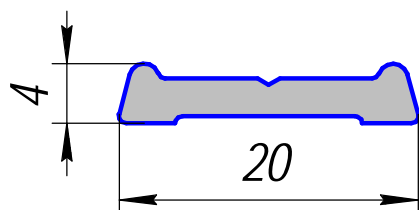

ПА-46; 0,149кг/п.м.

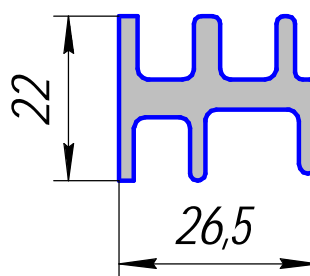

ПА-51; 0,669кг/п.м.

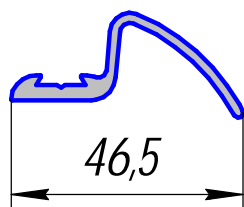

ПА-47; 0,441кг/п.м.

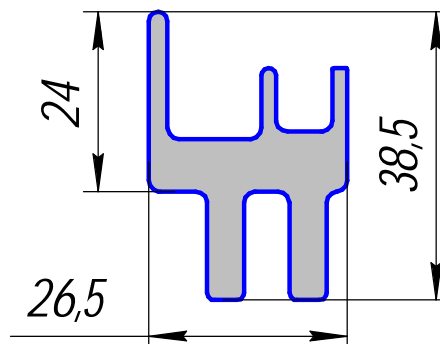

ПА-52; 1,137кг/п.м.

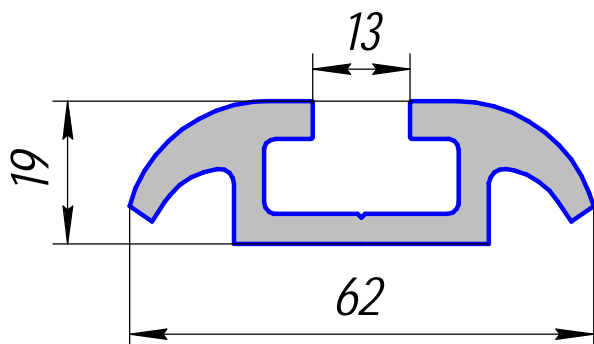

ПА-48; 1,407кг/п.м.

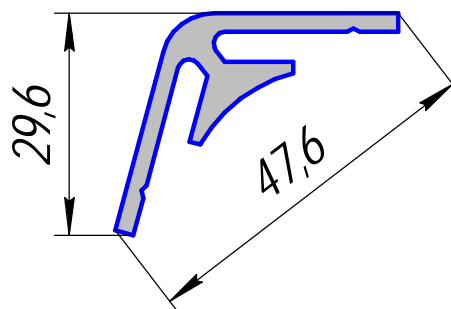

ПА-53; 0,595кг/п.м.

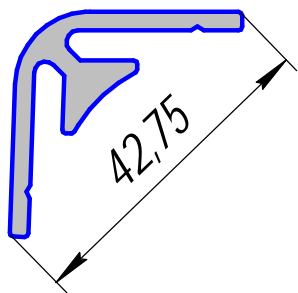

ПА-54; 0,539кг/п.м.

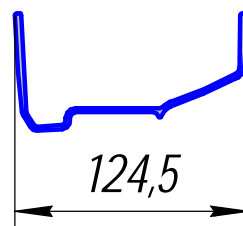

ПА-62; 1,575кг/п.м.

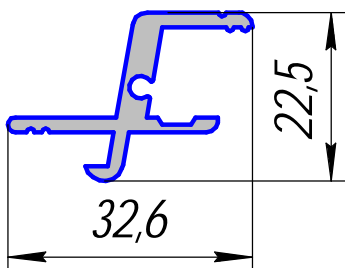

ПА-57; 0,376кг/п.м.

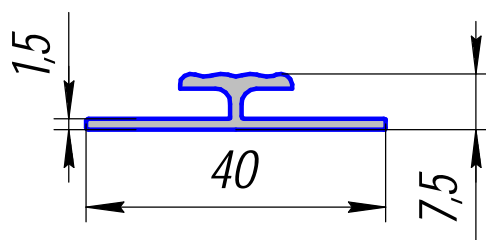

ПА-63; 0,256кг/п.м.

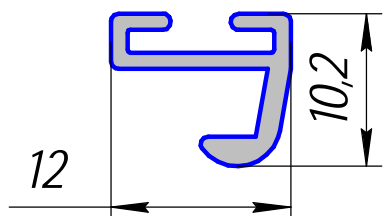

ПА-58; 0,106кг/п.м.

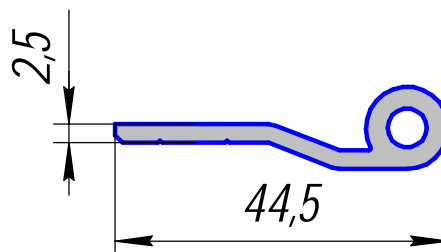

ПА-64; 0,445кг/п.м.

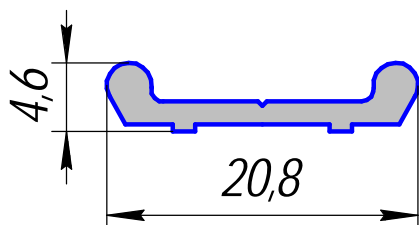

ПА-61; 0,118кг/п.м.

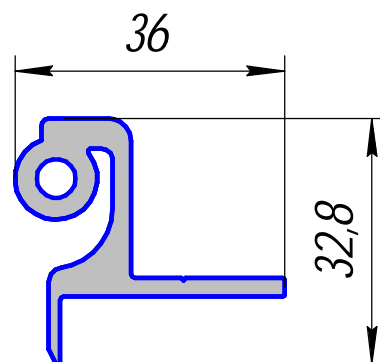

ПА-65; 0,738кг/п.м.

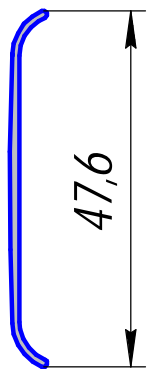

ПА-66; 0,157кг/п.м.

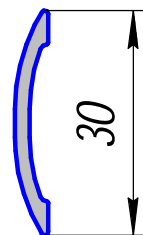

ПА-76; 0,164кг/п.м.

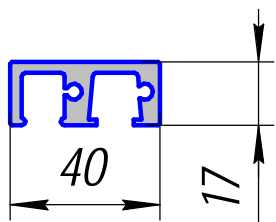

ПА-68; 0,859кг/п.м.

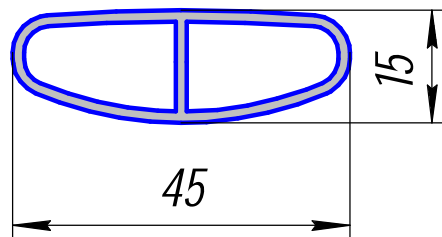

ПА-98; 0,453кг/п.м.

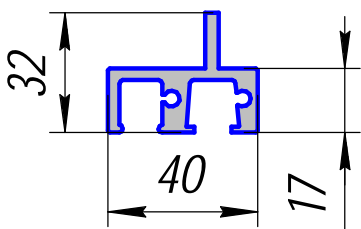

ПА-69; 1,002кг/п.м.

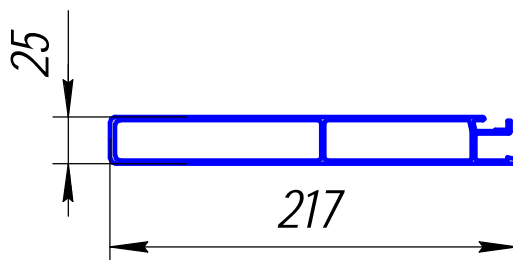

ПА-103; 2,538кг/п.м.

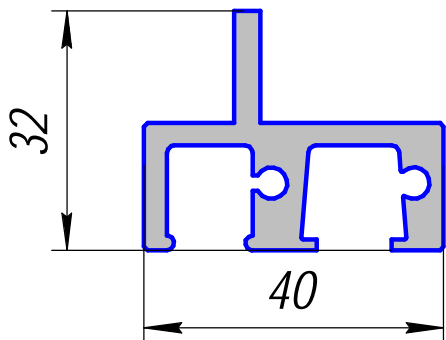

ПА-70; 1,002кг/п.м.

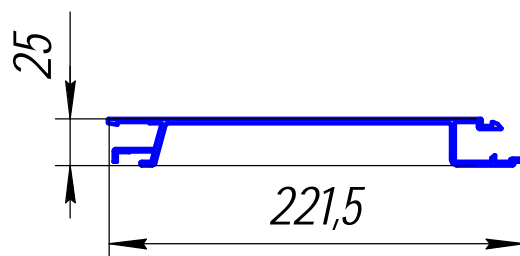

ПА-104; 1,975кг/п.м.

Профили автомобильные

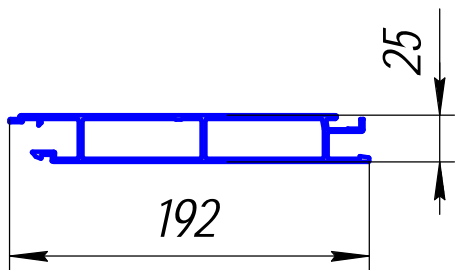

ПА-105; 2,270кг/п.м.

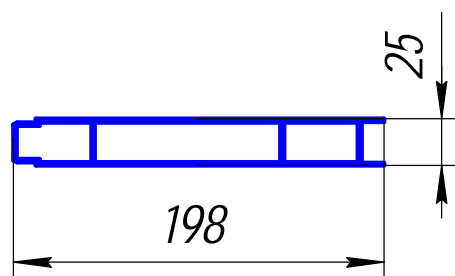

ПА-112; 2,358кг/п.м.

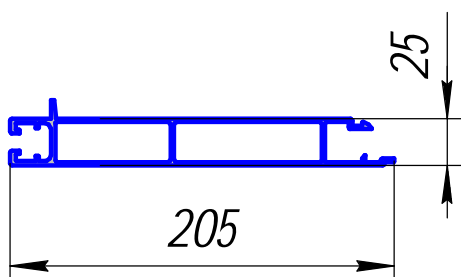

ПА-106; 2,662кг/п.м.

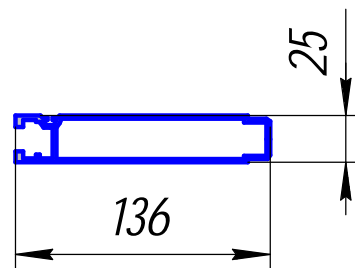

ПА-113; 1,703кг/п.м.

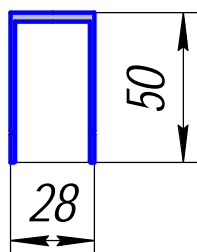

ПА-110; 0,608кг/п.м.

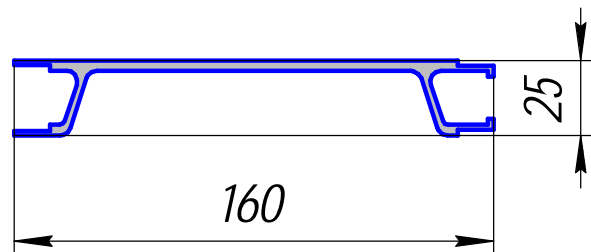

ПА-114; 1,932кг/п.м.

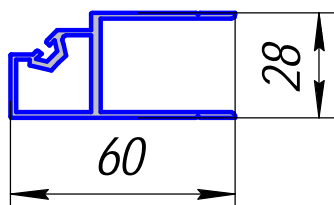

ПА-111; 0,794кг/п.м.

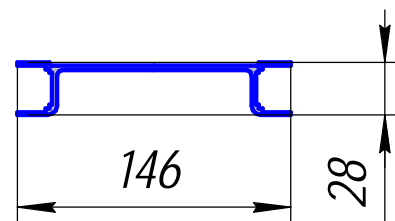

ПА-115; 1,444кг/п.м.

Профили автомобильные

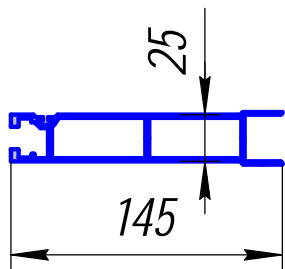

ПА-116; 1,858кг/п.м.

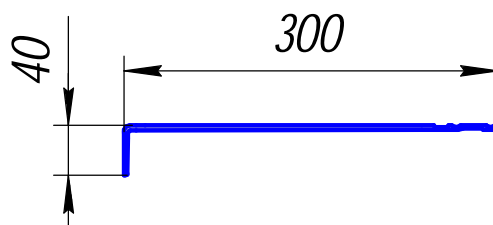

ПА-199; 3,179кг/п.м.

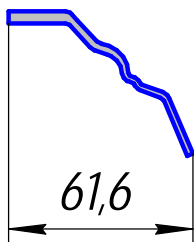

ПА-117; 0,626кг/п.м.

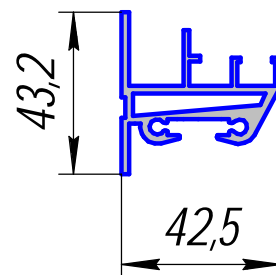

ПА-202; 1,047кг/п.м.

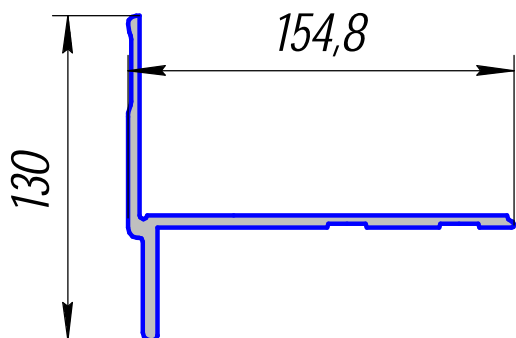

ПА-196; 3,636кг/п.м.

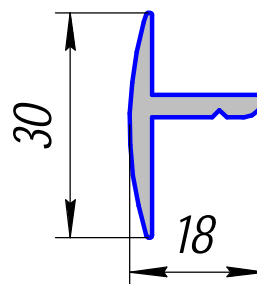

ПА-203; 0,296кг/п.м.

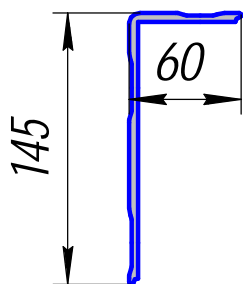

ПА-197; 2,227кг/п.м.

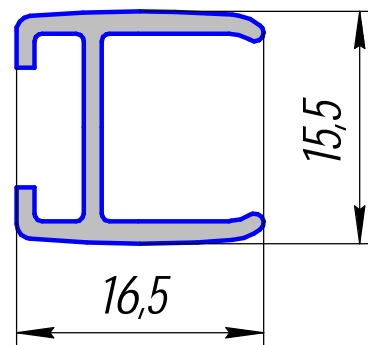

ПО-125-1; 0,178кг/п.м.

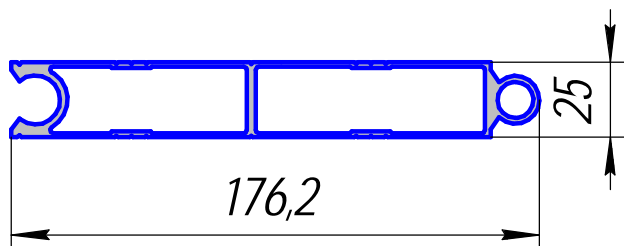

ЭПЗ-026; 2,250кг/п.м.

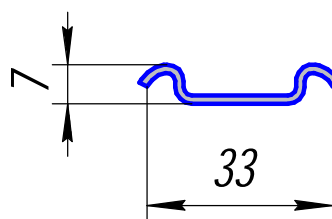

ЭПО-060; 0,180кг/п.м.

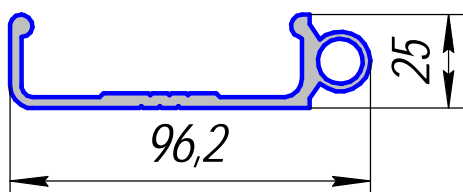

ЭПЗ-027; 1,398кг/п.м.

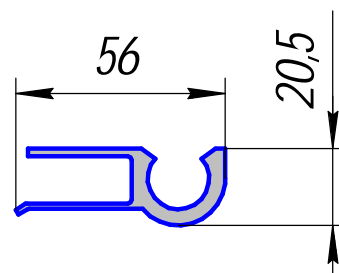

ЭПО-065; 0,875кг/п.м.

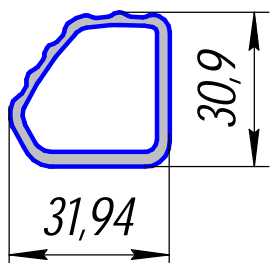

ЭПЗ-029; 0,664кг/п.м.

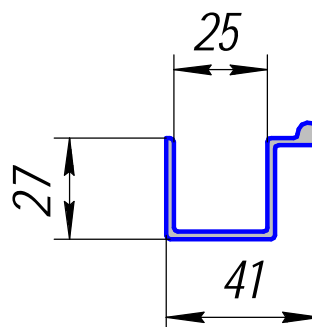

ЭПО-066; 0,547кг/п.м.

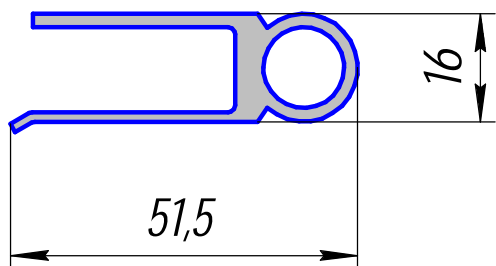

ЭПЗ-064; 0,671кг/п.м.