

БПО-305П; 0,130кг/п.м.

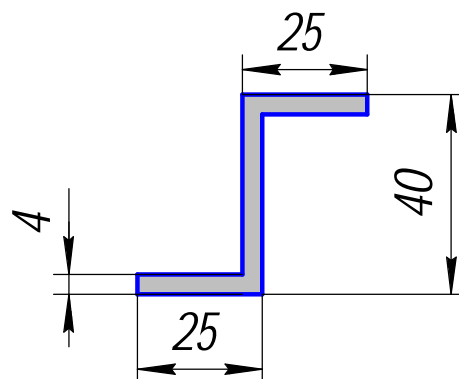

НП-504; 0,889кг/п.м.

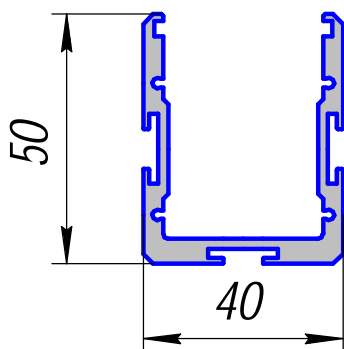

НП-440; 1,244кг/п.м.

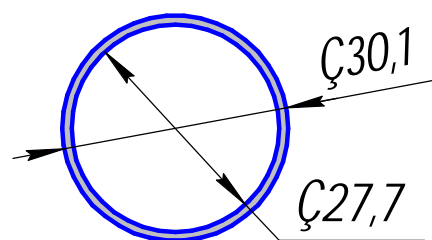

НП-638; 0,295кг/п.м.

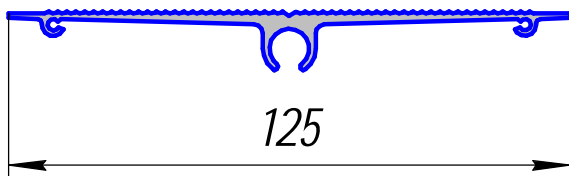

НП-462; 0,840кг/п.м.

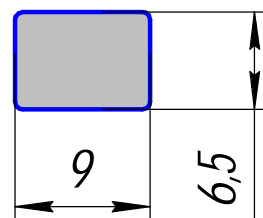

ПА-7; 0,158кг/п.м.

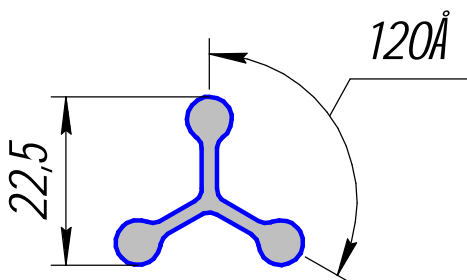

НП-478; 0,361кг/п.м.

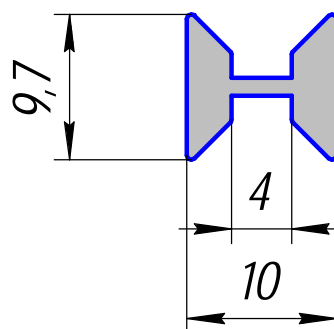

ПА-10; 0,134кг/п.м.

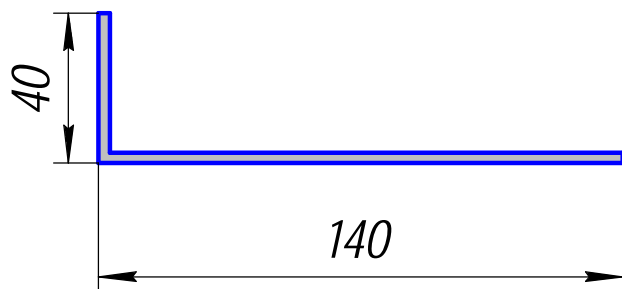

ПА-17; 1,328кг/п.м.

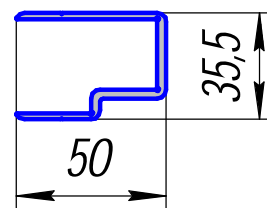

ПА-100; 0,824кг/п.м.

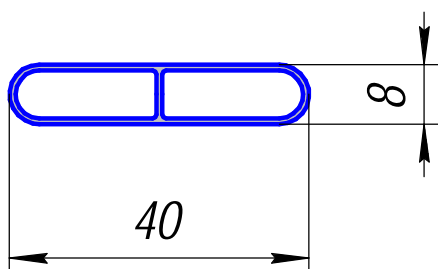

ПА-23; 0,202кг/п.м.

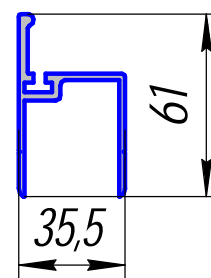

ПА-101; 0,903кг/п.м.

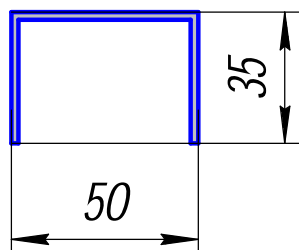

ПА-60; 0,633кг/п.м.

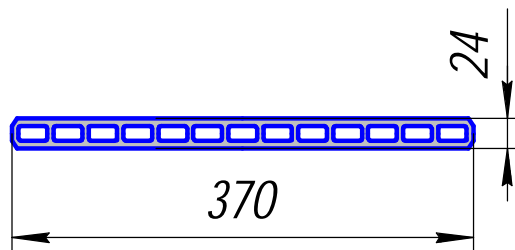

ПА-107; 14,326кг/п.м.

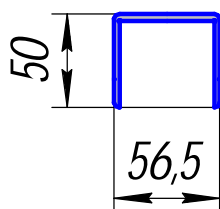

ПА-99; 1,337кг/п.м.

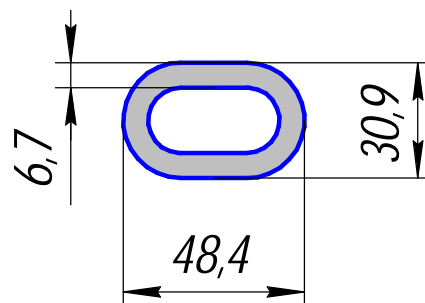

ПА-118; 2,016кг/п.м.

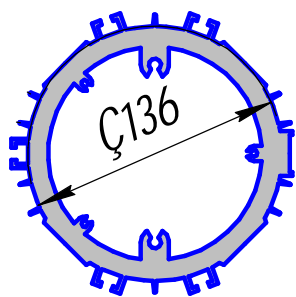

ПА-125; 14,574кг/п.м.

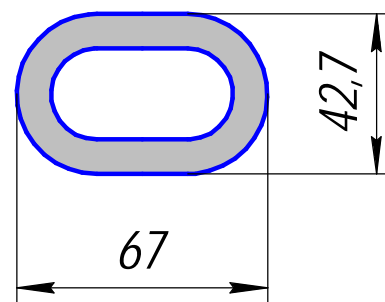

ПА-200; 3,836кг/п.м.

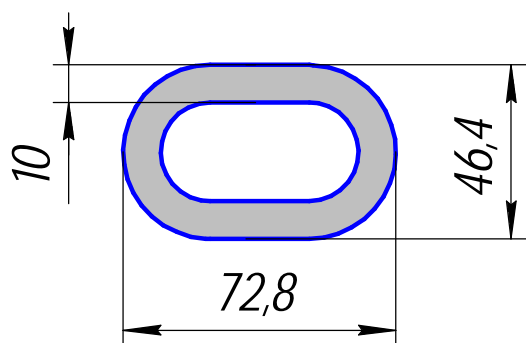

ПА-131; 4,530кг/п.м.

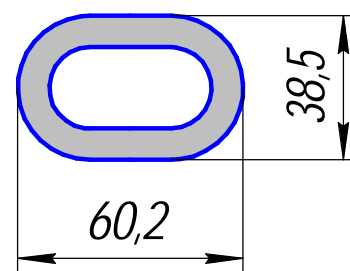

ПА-201; 3,141кг/п.м.

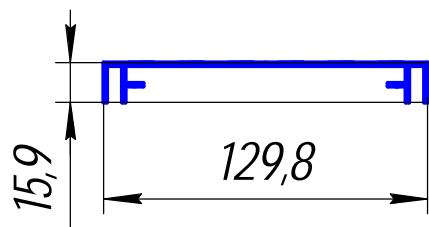

ПА-191-01; 0,709кг/п.м.

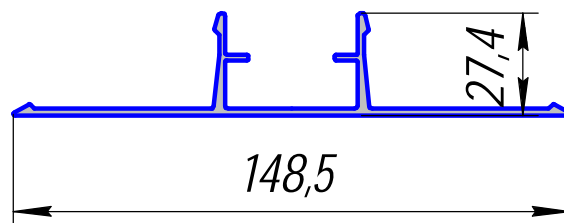

ПА-212; 1,079кг/п.м.

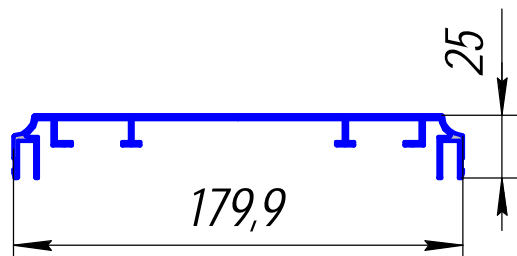

ПА-194; 1,314кг/п.м.

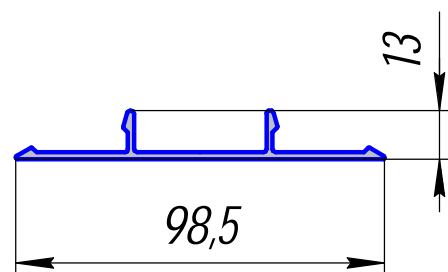

ПА-213; 0,610кг/п.м.

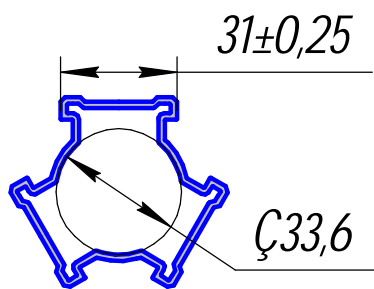

ПА-214; 0,94кг/п.м.

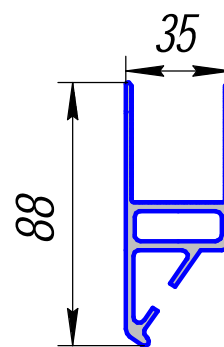

ПА-253; 1,544кг/п.м.

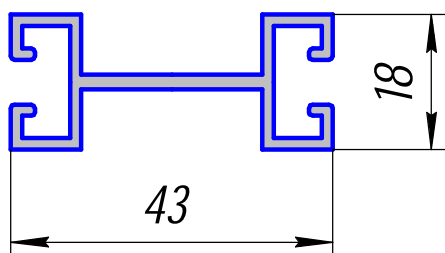

ПА-242; 0,505кг/п.м.

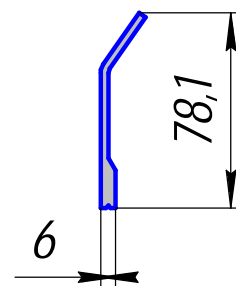

ПА-257; 0,806кг/п.м.

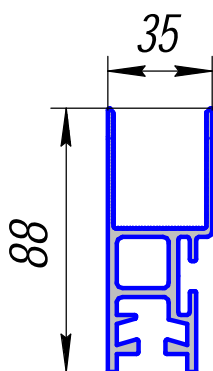

ПА-251; 1,897кг/п.м.

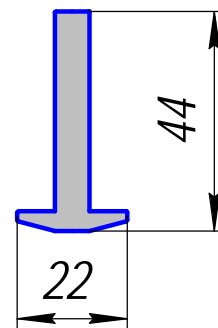

ПА-258; 0,956кг/п.м.

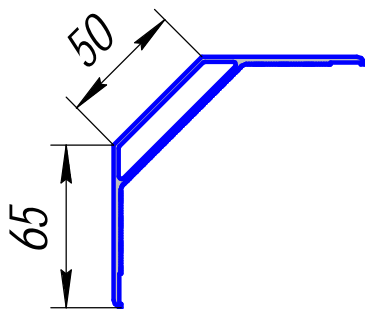

ПА-252; 1,294кг/п.м.

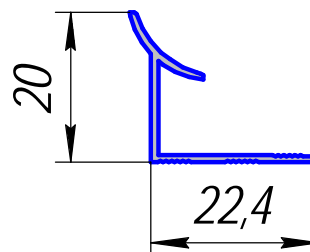

ПА-274; 0,128кг/п.м.

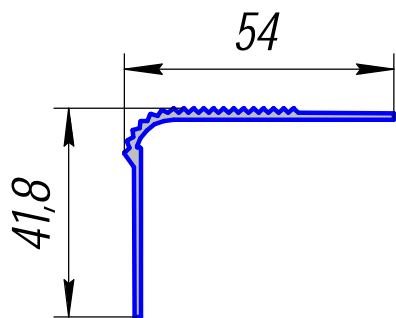

ПА-279; 0,379кг/п.м.

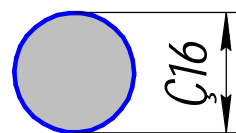

Пруток КР16; 0,545кг/п.м.

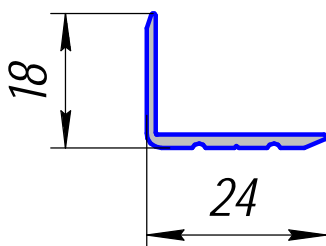

ПА-280; 0,156кг/п.м.

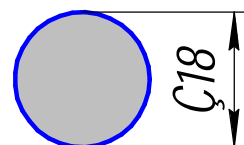

Пруток КР18; 0,690кг/п.м.

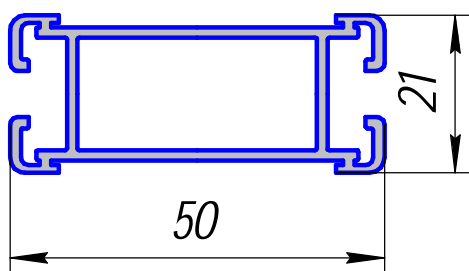

ПА-305; 0,631кг/п.м.

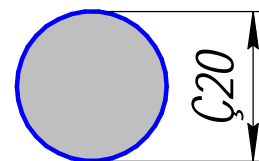

Пруток КР20; 0,851кг/п.м.

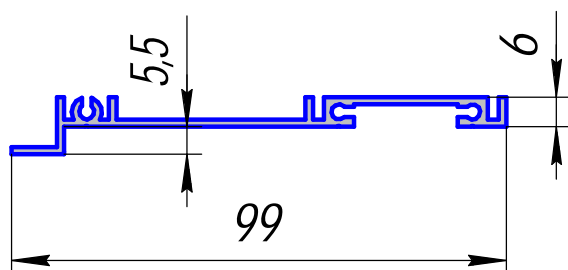

ПА-309; 0,622кг/п.м.

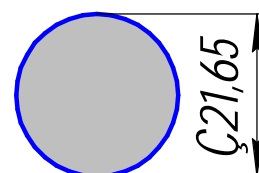

Пруток КР21,65; 0,999кг/п.м.

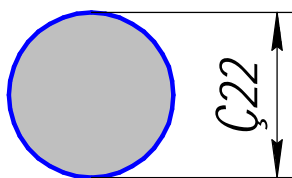

Пруток КР22; 1,030кг/п.м.

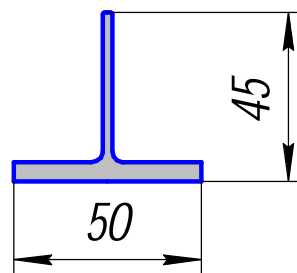

420366; 0,970кг/п.м.

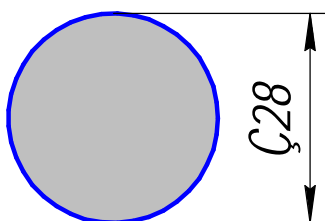

Пруток КР28; 1,669кг/п.м.

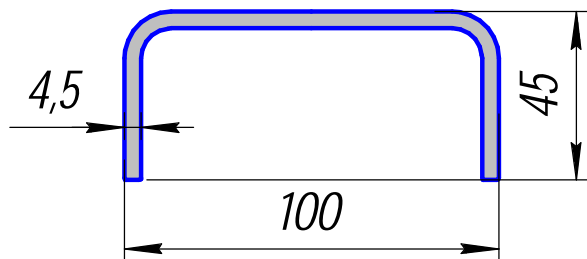

440361; 2,099кг/п.м.

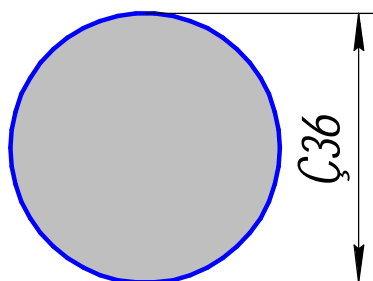

Пруток КР36; 2,758кг/п.м.

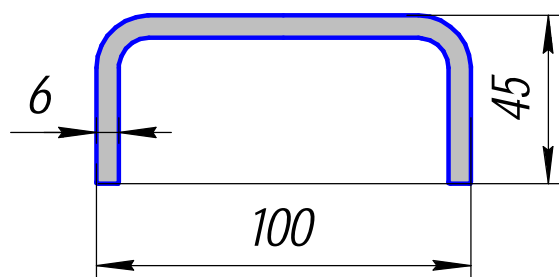

440362; 2,740кг/п.м.

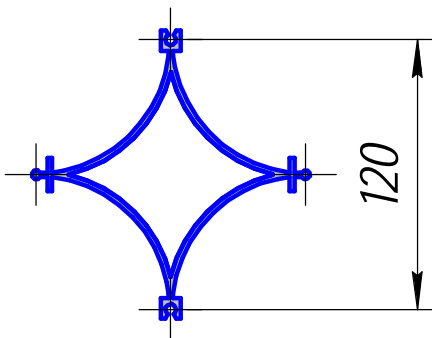

ЭПЗ-001; 2,610кг/п.м.

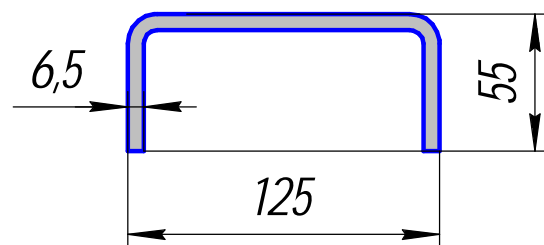

440412; 3,778кг/п.м.

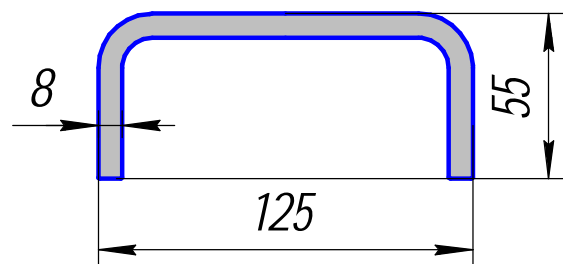

440416; 4,487кг/п.м.

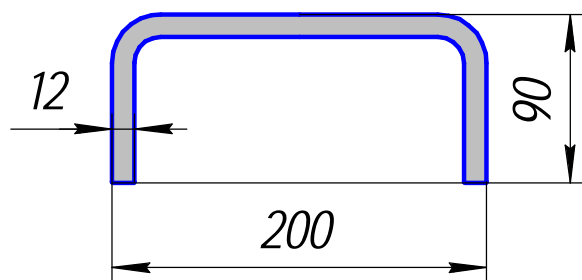

440495; 11,018кг/п.м.